

TAMBORA 67" ACRYLIC RECTANGULAR TUB

Cat. No.
ATRECN67ID-XXXX



faucet not included

L: 66-3/4"
W: 31-5/8"
H: 23-3/8"

Water depth to top of tub: 18"
Water depth to overflow: 14-1/2"
Center drain to back of rim: 16-1/2"
Bottom of drain to floor: 3-7/8"
Bathting well to floor: 5"

The following is recommended for ATRECN67ID tubs:

- Freestanding filler: part#7932, 7952, or 7918
(Does not need bath supplies)

ATRECN67ID tubs can have 8" deck holes drilled #8 WIDESPREAD upon request. The widespread is compatible with the Shelby Roman Tub Faucet with Handshower 7801-ML-XX. Tubs that have been drilled 8" deck holes are "special order and are not returnable."

Gallon Capacity : 88
Shipping Weight: 135 lbs.
Empty Weight: 99 lbs.
Filled Weight : 830 lbs.



For easier installation we
recommend use of 5598-ITD
Easy Install Rough-In Kit

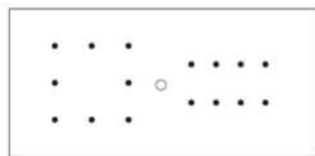

(Air jet configuration if system is added,
more info on page 2.)

Features:

- ▶ Interior and exterior walls acrylic sheets
- ▶ No faucet holes
- ▶ No overflow trim
- ▶ Rim is 3/4" wide
- ▶ Drain included
- ▶ Angle slope of tub: 26°
- ▶ Tap deck: 3-1/2"
- ▶ Drain covers included (available in 8 finishes)
- ▶ Tub is thoroughly inspected before shipment
- ▶ Option to add foam insulation between tub walls available
- ▶ **New:** Air jet system now available, more info on page 2



Tub Colors:

WH Gloss White
MT Matte White

Drain Trim Finishes:

BN Brushed Nickel
CP Polished Chrome
ORB Oil Rubbed Bronze
MB Matte Black
PB Polished Brass
PN Polished Nickel
WT White
MT Matte White

Custom Colors Available (inside of tub is always white enamel):
Painted bathtubs are considered "special order" and are not returnable

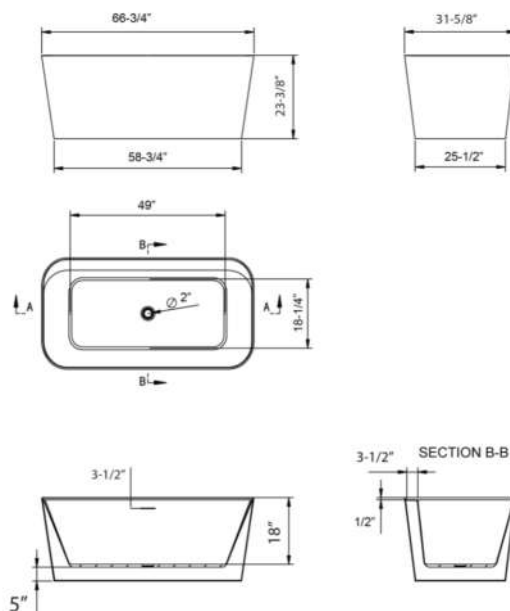

Dimensions of fixture are nominal and specifications subject to change without notice.

BATHTUB AIR JET KIT

Cat. No.
AIR KIT 1, AIR KIT 2

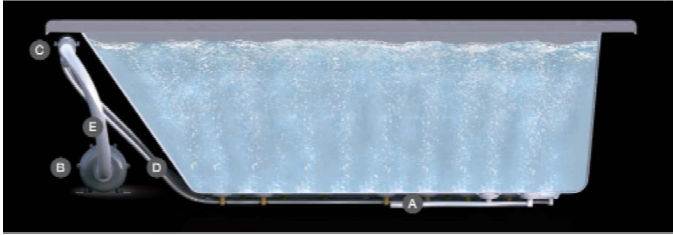

- A** AIR JET - Bottom air jets for maximum bubble action.
- B** BLOWER - The heart of the massage system.
- C** MANIFOLD - Double back flow security prevention device.
- D** FLEXIBLE PVC HOISING - IAPMO certified.
- E** MAIN AIR INTAKE HOSE - High temperature and pressure resistant.

Features:

- ▶ 750 Watt blower motor operates system
- ▶ 300 Watt air heater warms air
- ▶ System powered by 120V
- ▶ 16 brass air jets placed in bottom of tub
- ▶ Each air jet has 24 holes
- ▶ Air jet caps available in white (AIR KIT 1) or black (AIR KIT 2)
- ▶ Includes 1 1/4" x 3' main air hose plus 1 1/4" x 9' extension hose
- ▶ Automatic system purge after each use
- ▶ Automatic safety timer turns off system after 20 minutes
- ▶ Includes water tight remote control
- ▶ Compatible with most acrylic, copper and resin tubs with no feet
- ▶ Not available with cast iron tubs or tubs with feet

Air Kit is installed in tub before shipment

INSIDE TUB VIEW - WILL VARY BY TUB DESIGN



Air Jet



Remote

Oval bathtub
Sample jet configuration

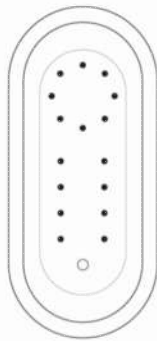

with end drain

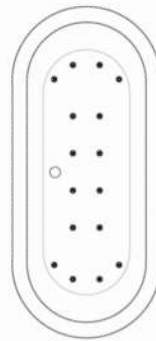

with center drain

Rectangular bathtub
Sample jet configuration

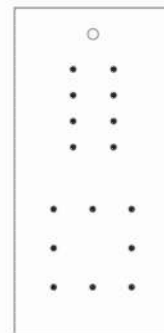

with end drain

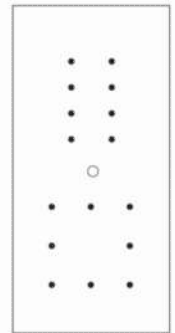

with center drain

Round bathtub
Sample jet configuration

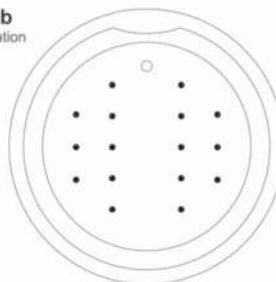

These diagrams are general representations. Jet placement may vary dependent on tub shape

Features:

(16) Maxi Air Jets



Elbows for air jets



Tees for air jets