

# MORTANA 69" ACRYLIC DOUBLE SLIPPER TUB

Cat. No.  
ATDSN69ID-XXXX



faucet not included

L: 69-1/4"  
W: 31-5/8"  
H: 23" center height, 26"

Water depth to top of tub: 17-3/4"  
Water depth to overflow: 14-1/2"  
Center drain to back of rim: 15-3/8"  
Bottom of drain to floor: 3-3/4"  
Bathing well to floor: 4-3/4"

## Features:

- ▶ Interior and exterior walls acrylic sheets
- ▶ No faucet holes
- ▶ Overflow trim included
- ▶ Rim is 3-1/4" wide
- ▶ Drain included
- ▶ Angle slope of tub: 21°
- ▶ Drain and overflow covers included (available in 8 finishes)
- ▶ Tub is thoroughly inspected before shipment
- ▶ Option to add foam insulation between tub walls available
- ▶ **New:** Air jet system now available, more info on page 2



## Tub Colors:

**WH** Gloss White

## Drain and Overflow Trim Finishes:

**BN** Brushed Nickel  
**CP** Polished Chrome  
**ORB** Oil Rubbed Bronze  
**MB** Matte Black  
**PB** Polished Brass  
**PN** Polished Nickel  
**WT** White  
**MT** Matte White

**Custom Colors Available** (inside of tub is always white enamel):  
Painted bathtubs are considered "special order" and are not returnable

The following is recommended for  
**ATDSN69ID TUBS:**  
• Freestanding filler: part #7902 or #7934  
(Supplies included with filler)

Gallon Capacity : 63  
Shipping Weight: 142 lbs.  
Empty Weight: 98 lbs.  
Filled Weight : 621 lbs.



For easier installation we recommend use of 5598-ITD Easy Install Rough-In Kit

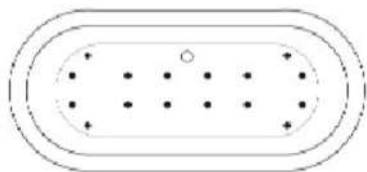

(Air jet configuration if system is added, more info on page 2.)

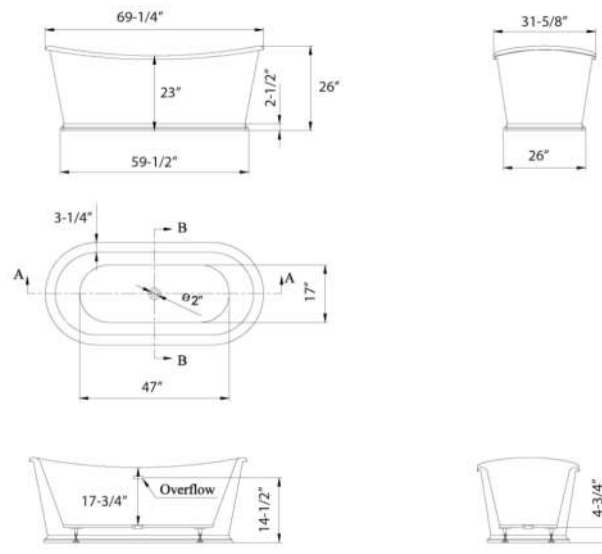

Dimensions of fixture are nominal and specifications subject to change without notice.

# BATHTUB AIR JET KIT

Cat. No.  
AIR KIT 1, AIR KIT 2

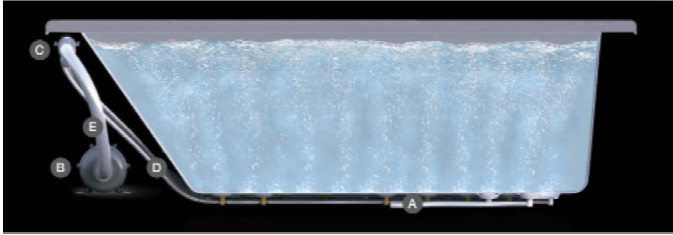

- A** AIR JET - Bottom air jets for maximum bubble action.
- B** BLOWER - The heart of the massage system.
- C** MANIFOLD - Double back flow security prevention device.
- D** FLEXIBLE PVC HOISING - IAPMO certified.
- E** MAIN AIR INTAKE HOSE - High temperature and pressure resistant.

## Features:

- ▶ 750 Watt blower motor operates system
- ▶ 300 Watt air heater warms air
- ▶ System powered by 120V
- ▶ 16 brass air jets placed in bottom of tub
- ▶ Each air jet has 24 holes
- ▶ Air jet caps available in white (AIR KIT 1) or black (AIR KIT 2)
- ▶ Includes 1 1/4" x 3' main air hose plus 1 1/4" x 9' extension hose
- ▶ Automatic system purge after each use
- ▶ Automatic safety timer turns off system after 20 minutes
- ▶ Includes water tight remote control
- ▶ Compatible with most acrylic, copper and resin tubs with no feet
- ▶ Not available with cast iron tubs or tubs with feet

Air Kit is installed in tub before shipment

## INSIDE TUB VIEW - WILL VARY BY TUB DESIGN



Air Jet



Remote

**Oval bathtub**  
Sample jet configuration

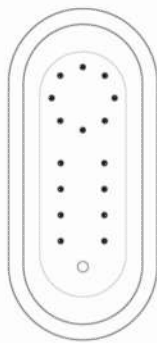

with end drain

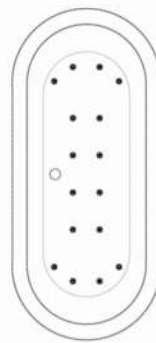

with center drain

**Rectangular bathtub**  
Sample jet configuration

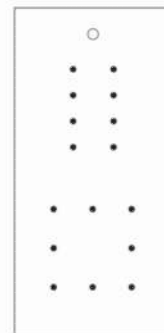

with end drain

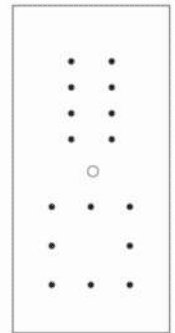

with center drain

**Round bathtub**  
Sample jet configuration

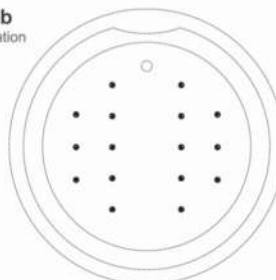

These diagrams are general representations.  
Jet placement may vary dependent on tub shape

### Features:

(16) Maxi Air Jets



Elbows for air jets



Tees for air jets